

KEJIA NING<sup>1</sup>, GEN HUANG<sup>1</sup>, HONGXIANG XU<sup>1</sup>,  
LUN WU<sup>1</sup>, XIAOBING LI<sup>2</sup>, YONGTIAN WANG<sup>2</sup>

## EFFECT OF GAS HOLDUP ON THE EFFICIENCY OF CYCLONIC-STATIC MICROBUBBLE FLOTATION COLUMN FOR OILY WASTEWATER TREATMENT

A cyclonic-static microbubble flotation column of a novel construction was used in oil–water separation fields and has high efficiency for oil–water separation. The gas holdup is a key parameter for the evaluation of the performance of a flotation column. The gas holdup, closely related to the bubble size, bubble velocity and superficial gas velocity, is one of the most important parameters characterizing the hydrodynamics of a bubble column. The effect of gas holdup in a cyclonic-static microbubble flotation column was investigated. In addition, several operating parameters such as the circulating pressure, superficial gas velocity, and frother consumption were also investigated. The gas holdup was positively correlated to the superficial gas velocity. The gas holdup of clean water and oil wastewater increased along with the increase of the frother consumption. The separation mechanism of cyclonic-static microbubble flotation column was analyzed.

### 1. INTRODUCTION

Water and oil are two of the major resource issues facing the world. After many oilfields were brought into the mid to late petroleum exploitation period [1–3], oily wastewater has become one key issue for the production process of the oilfield industry and environment protection [4–6]. In order to handle the oily wastewater issue, a cyclonic-static microbubble flotation column with a unique structure characterizing frother consumption has been introduced to the oil–water separation field [7–9].

The cyclonic-static microbubble flotation column was always used in mineral processing and coal preparation processing before it has been introduced in water treatment.

---

<sup>1</sup>School of Chemical and Environmental Engineering, China University of Mining and Technology, Beijing, 100083, China, corresponding author Hongxiang Xu, e-mail address: xuhongxiang001@163.com

<sup>2</sup>School of Chemical Engineering and Technology, Chinese National Engineering Research Center of Coal Preparation and Purification, China University of Mining and Technology, Xuzhou, Jiangsu, 221116, China.

Under the optimum operating parameters, the oil content in the final effluent reached to the 16.49 mg/dm<sup>3</sup> [10, 11]. But the functional mechanism of the cyclonic-static microbubble flotation column used in oil–water separation is not clear. Many parameters influence the performance of the flotation column, especially the gas holdup [12].

The gas holdup, closely related to the bubble size, bubble velocity and superficial gas velocity, is one of the most important parameters characterizing the hydrodynamics of a bubble column [13, 14]. In addition, gas holdup not only affects the collection kinetics but also determines the phase residence time [15]. The gas holdup is a key parameter for the performance evaluation of flotation column. Effect of gas holdup on the efficiency of a cyclonic-static microbubble flotation column (FCSMC) for oily wastewater treatment was investigated in this paper.

## 2. EXPERIMENTAL

*Materials.* The wastewater samples were taken from the primary oil, gas and water separation tank in the United Station of Shengli Isolated Island Oilfield No. 6. The oily wastewater quality was bad (Table 1). The sample color was yellowish-brown, with lots of dispersed oil and suspended matter. Besides, due to the high oil content and high content of suspended matters and polymers, the emulsion in the oily wastewater was stable, and it was hard to dispose.

Table 1

Results of the quality analysis of the oily wastewater  
in the United Station of Shengli Isolated Island Oilfield No. 6

pH	7.0–7.4
Temperature, °C	35–39
Density, g/cm <sup>3</sup>	910–960
Viscosity, mPa·s	1.5238
Oil content, mg/dm <sup>3</sup>	2000–2500
HPAM content, mg/dm <sup>3</sup>	150–300
Suspended solid content, mg/dm <sup>3</sup>	50–680

*Equipment and operating conditions.* The experimental system included the flotation column separation system (FCSMC) and measurement control system. The construction of the FCSMC is shown in Fig. 1. It consisted of a cylinder, a circulating pump, a bubble generator, a sieve plate and some filler materials. The oily water was pumped into the flotation column. Clean water separated by flotation was discharged from the bottom of the flotation column. The oily foam composed of oil, bubble and suspended solids was collected in a foam tank and then discharged.

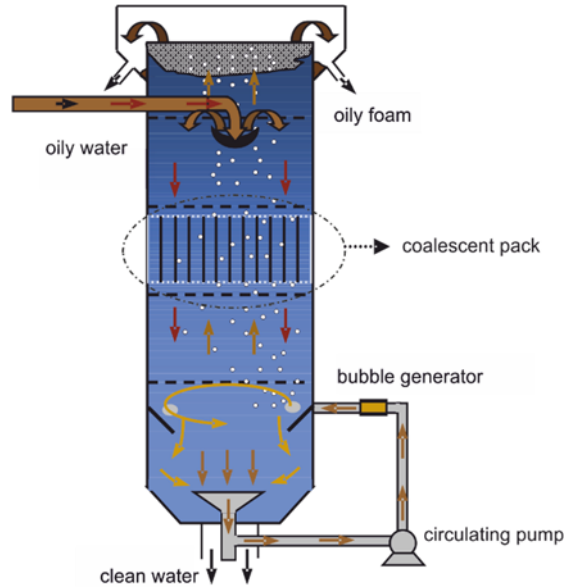

Fig. 1. Cyclone-static microbubble flotation column

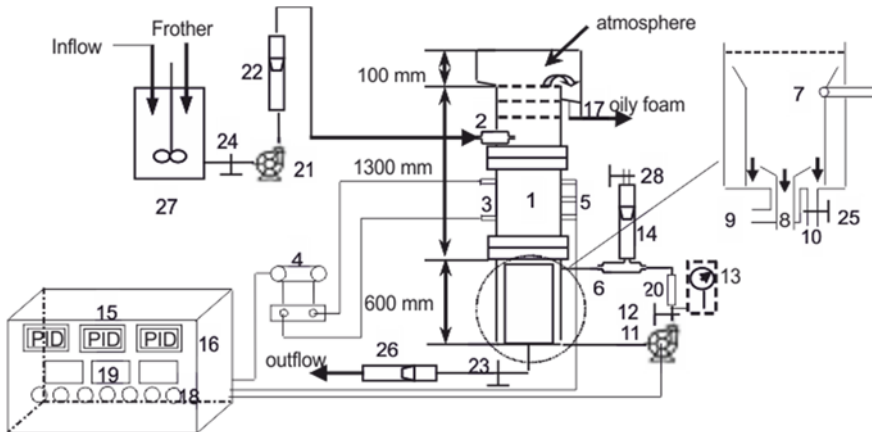

Fig. 2. Wastewater treatment process with gas holdup measurement system: 1 – flotation column, 2 – feeding port, 3, 4 – conversion interface module, 5 – pressure transmitter, 6 – bubble generator, 7 – circular tube inlet, 8 – middling cycle mouth, 9 – purified underflow outlet, 10 – water outlet, 11 – circulation pump, 12, 23, 24, 25, 28 – valves, 13 – pressure transmitter, 14 – gas flowmeter, 15 – control cabinet, 16 – PID controller, 17 – water outlet, 18 – switch, 19 – frequency converter, 21 – feeding pump, 27 – mixing tank, 20, 26 – glass rotor flowmeters (water)

The process of treating oily wastewater using the cyclonic-static microbubble flotation column (FCSMC) with the measurement control system is shown in Fig. 2. The separation system was composed of the cyclonic-static microbubble flotation column,

feeding pump (for inflow and outflow), circulating pump, mixing tank (dosing and mixing), and other devices. The cyclonic-static microbubble flotation column made of organic glass material was 2000 mm high, and 100 mm in diameter. The measurement control system was composed of a gas flowmeter, liquid flowmeter, electric control valve, PID digital regulator and a gas holdup determinator. The automatic control system for the flotation column liquid level was composed of a pressure transmitter, electronic control valve for straight travel and a PID digital regulator. Firstly, the oily wastewater from the primary separation tank entered into the mixing drum and its flow was regulated. Then the inflow was pumped from the mid-upper part of the flotation column via the feeding pump; lastly, the outflow was drained from the flotation column bottom via the control valve. The aeration rate was measured and regulated with a gas flowmeter, and the circulating pressure was regulated by changing the speed of the circulating pump.

*Experimental methods.* The oil removal and suspended solids removal efficiencies were used to evaluate the oil–water separation efficiency of the cyclonic-static microbubble flotation column. Sampling was made at the sampling point 2 (Fig. 2) of the feeding port, the sampling point 9 (Fig. 2) of purified underflow outlet (Fig. 1), and the oil concentration of two points were  $C_2$  and  $C_9$ . The contents of suspended solids at the two points were  $m_2$  and  $m_9$ .

The oil removal efficiency  $R$  was

$$R = \left( 1 - \frac{C_9}{C_2} \right) \times 100\% \quad (1)$$

and the suspended solids removal efficiency  $S$

$$S = \left( 1 - \frac{m_9}{m_2} \right) \times 100\% \quad (2)$$

The oil concentration was measured using a spectrophotometer UV-4802S by the ultraviolet method [16, 17]. Petroleum ether was used as the extraction agent. The 256 nm wavelength was used in the spectrophotometric method. The working curve method was applied to the determination and blank solution was used as the reference.

The gas holdup ( $\varepsilon_g$ ) is the percent of gas volume in the flotation column. It is mainly the ratio of the volume of liquid replaced after the bubble supplying into the flotation column [16]:

$$\varepsilon_g = \frac{V_g}{V_g + V_l} \quad (3)$$

where,  $V_g$ ,  $V_l$  refer to the volume of gas and liquid in flotation column

This experiment uses differential pressure to measure the local gas holdup of flotation column. It only considers liquid pressure and ignores the dynamic pressure, and the pressure produced by the gas.

The circulating pressure  $P$  refers to the pressure at the circulating pump outlet of the flotation column. By the controlling the pressure, the tangential feeding flow can provide energy differing in magnitude to the cyclonic separation. In the experiment, the frequency converter (0–50 Hz) was used to change the circulating pump flow and regulate its outlet pressure. The superficial gas velocity refers to the amount of gas sucked into the flotation column via the bubble generator, which was measured and regulated via the gas flowmeter.

To investigate the influence of circulating pressure on wastewater treatment, the valve 12 and 28 are used to adjust the pressure magnitude and the superficial gas velocity, respectively. The superficial gas velocity is related with the circulating pressure, but it can be adjusted with the valve 28 (Fig. 2). Thus, the influence of both the circulating pressure of a constant value (0.66 m/s) of the superficial gas velocity and the circulating pressure with valve 28 wide open on wastewater treatment were investigated. The effect of circulating pressure of a constant value (0.66 m/s) of the superficial gas velocity on the oil and suspended solids removal efficiencies was investigated.

The relationship between the superficial gas velocity and gas holdup under the constant value (0.26 MPa) of the circulating pressure was investigated. To investigate the influence of frother consumption on gas holdup and removal efficiency, the pine camphor oil (0–20 mg/dm<sup>3</sup>) as a frother was added into the mixing tank.

### 3. RESULTS AND DISCUSSION

#### 3.1. EFFECT OF THE CIRCULATING PRESSURE

Dependences of the superficial gas velocity and gas holdup on the circulating pressure for the valve 28 wide open are shown in Figs. 3, 4, respectively. The effects of circulating pressure on the oil and suspended solids (ss) removal efficiencies are shown in Fig. 5. When the air inlet valve 28 is fully opened, both the aeration rate and the superficial gas velocity in the flotation column increase upon increasing the circulating pressure (Fig. 3, curve A). The aeration rate corresponds to changes in the circulation pressure when the air inlet valve is fully open. The higher the circulation pressure, the greater the circulating pump feeding is.

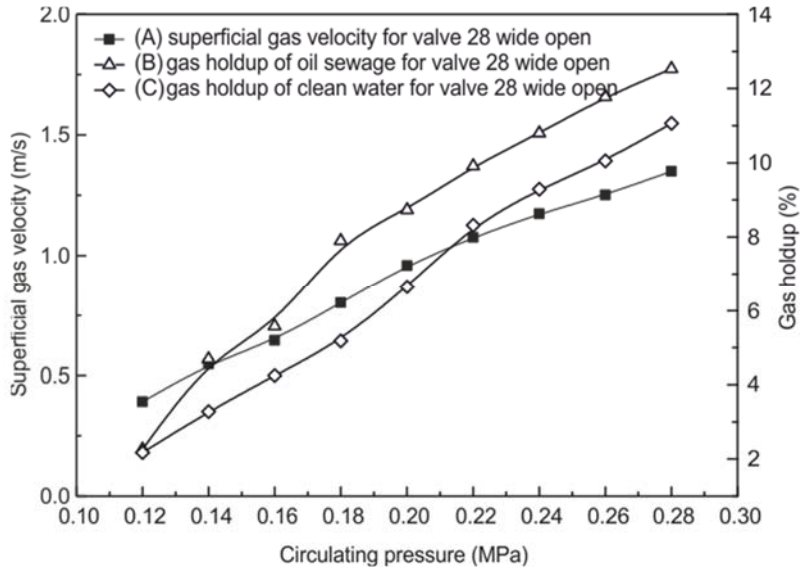

Fig. 3. Dependence the superficial gas velocity and gas holdup on the circulating pressure for the valve 28 wide open

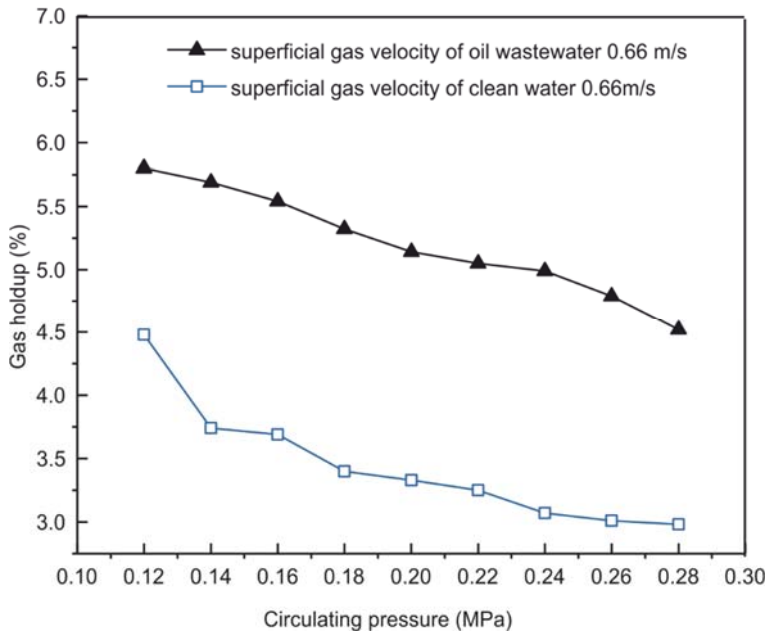

Fig. 4. Dependence of the gas holdup on the circulating pressure for the superficial gas velocity of 0.66 m/s

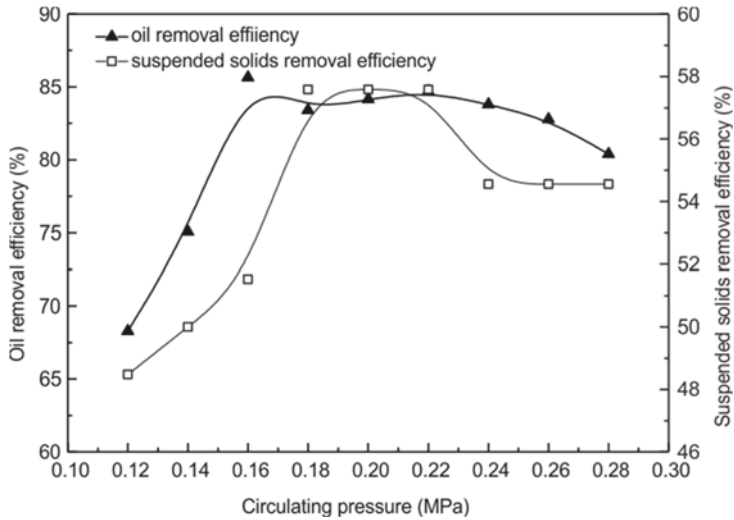

Fig. 5. Dependences of the oil and suspended solids removal efficiencies on the circulating pressure at the superficial gas velocity of 0.66 m/s

The gas holdup in the flotation column increased upon increasing the circulating pressure when the air inlet valve 28 was fully open (Fig. 3, curves B, C). The more circulating pressure, the greater the negative pressure generated by the bubble generator, the more air volume was sucked in the column and more bubbles were produced by the bubble generator. Therefore, the gas holdup increased upon increasing the circulating pressure. The gas holdup of oily wastewater was higher than the gas holdup of clean water. Pure water is not easy to blister, and can only form a small number of large size fragile bubbles, while oily wastewater forms stable bubbles because of containing oil type material which has a certain surface activity agent (HPAM) and the surface tension is lower than that of clean water.

When the superficial gas velocity had a constant value of 0.66 m/s, the gas holdup decreased gradually with the increase of circulating pressure (Fig. 4, curves A, B). The aeration rate and superficial gas velocity were adjusted with the air inlet valve. When circulating pressure was lower, the circulation was smaller, the water rising speed in column was slower, the speed of bubble rising in water was slower, the number of bubble at the unit time to stay in the measurement zone was more and the gas holdup was greater. However, with the increase of the circulating pressure, the size of bubbles decreased, the rising speed of bubble in the cylinder became higher and the number of bubbles in the measurement area decreased in time, so that the gas holdup decreased.

As shown in Fig. 5, upon increasing the circulating pressure, the oil removal and the suspended solids removal efficiencies first increased and then continuously decreased for circulating pressure above 0.2 MPa. The oil removal efficiency was better than the suspended solids removal efficiency.

The circulating pressure can provide energy for forming the suitable bubble size and oil–ss–bubble (oil–suspended solid–bubble) complex for colliding between oil droplets, suspended solids and bubbles. Thus upon increasing the circulating pressure, the oil and suspended solids removal efficiencies tended to increase. However when the circulating pressure exceeded 0.18 MPa, the oil droplets and oil–ss–bubble complexes were broken easily by larger shearing force, and the oil and suspended solids removal efficiencies decreased for circulating pressure above 0.2 MPa.

### 3.2. EFFECT OF THE SUPERFICIAL GAS VELOCITY

The relation between the superficial gas velocity and gas holdup is shown in Fig. 6. The dependences of oil and suspended solids removal efficiencies on the superficial gas velocity are shown in Fig. 7.

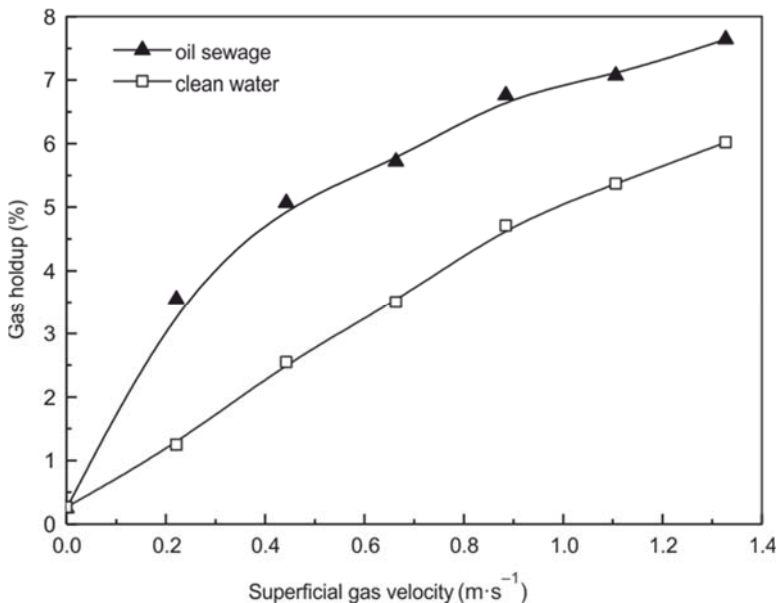

Fig. 6. Dependences of the gas holdup on the superficial gas velocity for oil sewage and clean water for the circulating pressure of 0.16 MPa

As shown in Fig. 6, when the circulating pressure had a constant value of 0.16 MPa and there was no frother addition, both the gas holdup of clean water and oil wastewater increased upon increasing the superficial gas velocity. When the superficial gas velocity was small, the increase of the gas holdup was significant. However, with the increase of the superficial gas velocity, the increase of the gas holdup was small. It can be concluded that the gas holdup will not increase continuously upon increasing the superficial



gas velocity. Therefore the methods which adjust the gas holdup through the change of the superficial gas velocity have certain scope limitation.

When the superficial gas velocity was constant, the gas holdup of oily wastewater was greater than the gas holdup of pure water because pure water was difficult to blister and the bubbles were not stable and broke easily.

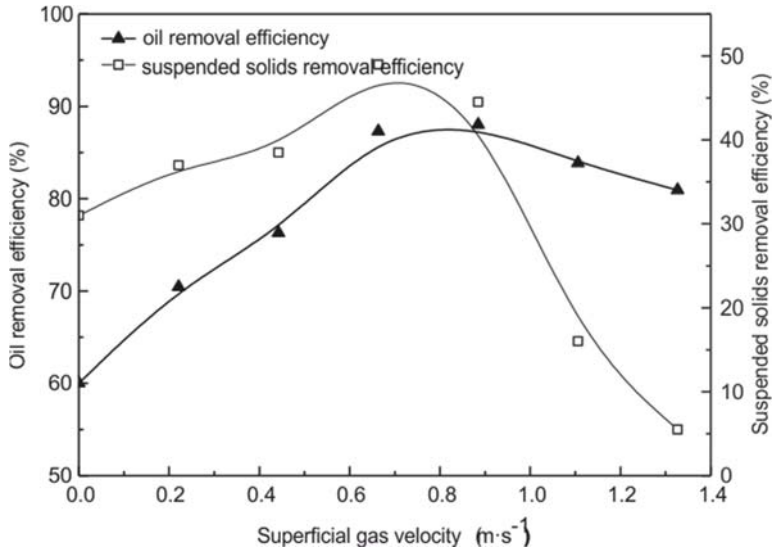

Fig. 7. Dependences of the oil and suspended solids removal efficiencies on the superficial gas velocity for the circulating pressure of 0.16 MPa

As shown in Fig. 7, with the increase of superficial gas velocity, the oil removal and suspended solids removal efficiencies initially increased and then continuously decreased after the superficial gas velocity reached around 0.8 m/s. The oil removal efficiency was higher than the suspended solids removal efficiency. When the superficial gas velocity was low in flotation processing, although the average bubble size was small and the merger phenomenon between the bubbles was not very strong, the number of bubbles which could form oil–ss–bubble complexes was low, so the oil and suspended solids removal efficiencies were low. With the increase of the superficial gas velocity, the number of the small bubbles also increased, the collision probability between the bubbles and oil droplets and the number of microbubbles which adhere to the oil droplets increased, the oil removal efficiency of the flotation column increased continuously. When the superficial gas velocity increased over 0.8 m/s, the merger between microbubbles become violent, the number of microbubbles able to catch oil droplets decreased. The flotation surface area reduced and the probability of catching oil droplets decreased; the increase of the superficial gas velocity changed the flotation column hybrid characteristics. Thus, the flotation efficiency decreased. The superficial gas velocity determined was around 0.60 m/s.

The oil and suspended solids removal efficiencies initially increased and then decreased with the increasing gas holdup (Figs. 6, 7). When the gas holdup was low, the number of bubbles which can form oil–ss–bubble complex was low, so the oil and suspended solids removal efficiencies were low. Upon increasing the gas holdup, the number of bubbles which can form oil–ss–bubble complex increased, and the oil and suspended solids removal efficiencies improved. When the gas holdup exceeded 5.8%, the merger between microbubbles become violent, the number of microbubbles able to catch the oil droplets and suspended solids decreased, so the oil and suspended solids removal efficiencies decreased.

### 3.3. EFFECT OF THE FROTHER CONSUMPTION

Upon increasing frother consumption, the gas holdup in both oily wastewater and pure water increased (Fig. 8). A high gas hold up may be obtained through adding a suitable amount of frother. Thus changing the frother consumption is an effective method of adjusting the gas holdup.

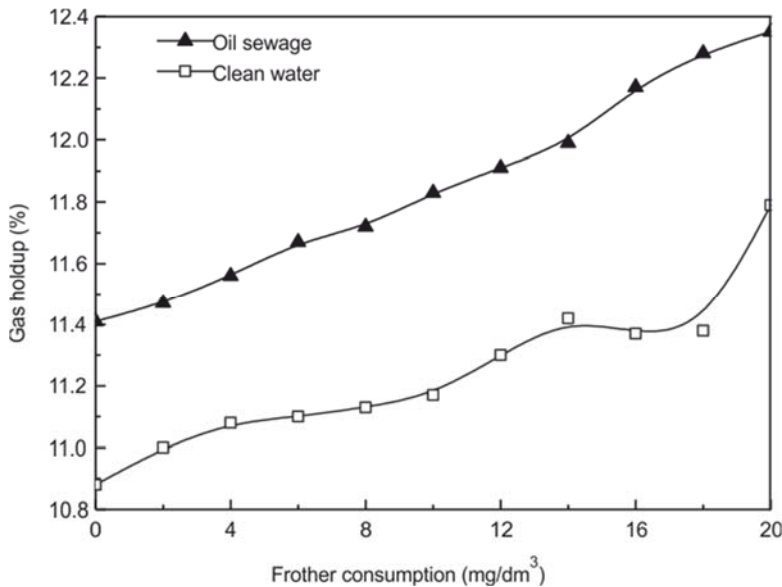

Fig. 8. Dependences of the gas holdup for oil sewage and clean water on the frother consumption for the circulating pressure of 0.16 MPa and gas velocity of 0.66 m/s

Frother can reduce the surface tension and decrease the probability of bubble coalescence, thus the quantity of small and stable bubbles increased upon increasing frother consumption. Under the same superficial velocity, the more bubbles, the greater the gas holdup. Thus, upon increasing frother consumption, the gas holdup in both oily wastewater and pure water increased.

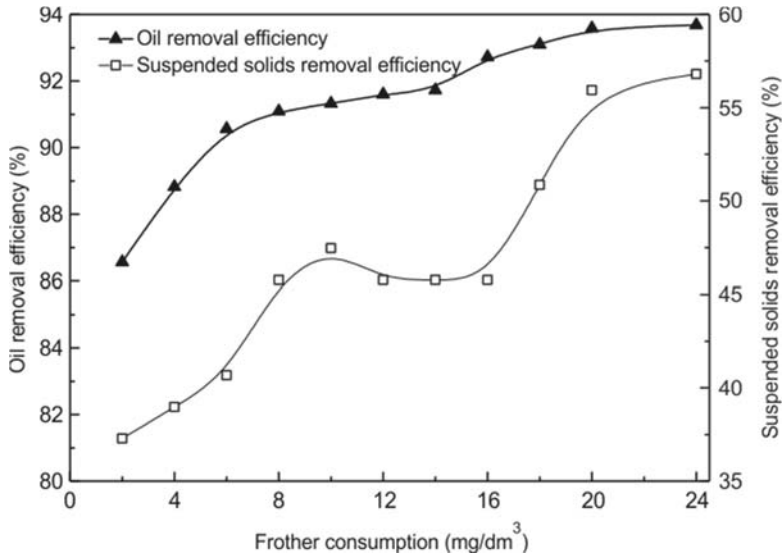

Fig. 9. Dependences of oil and suspended solids removal efficiencies on the frother consumption for the circulation pressure of 0.16 MPa and gas velocity of 0.66 m/s

Upon increasing the frother consumption, the oil removal and the suspended solids removal efficiencies showed an upward trend (Fig. 9). While the bubble size decreased, the quantity of bubbles increased and the collision probability between the bubbles and oil droplets increased. Thus the number of hydrophobic groups of oil grain flocs increased, and the quantity of steady oil–ss–bubble complexes increased; the flotation efficiency in the column was improved, and the oil and suspended solids removal efficiencies increased up to 56% and 93.5%, respectively, at the frother consumption of 20 mg/dm<sup>3</sup>. At the frother consumption higher than 20 mg/dm<sup>3</sup>, the oil removal efficiency and suspended solids removal efficiency increased slowly. Thus, the optimum frother consumption is 20 mg/dm<sup>3</sup> considering the cost and efficiency factors. However in practical industrial application, an appropriate frother concentration should be chosen due to differences in the prices of the frother.

#### 3.4. THE SEPARATION MECHANISM OF CYCLONIC-STATIC MICROBUBBLE FLOTATION COLUMN

Droplets with good floatability may be effectively separated through the column flotation. Droplets of poor floatability get into the bottom of the column prior to cyclone separation where they are pulled out by the circulating pump tangentially, through connecting line and bubble generator and then enter into the middle of the column. The bubble generator produced bubbles of suitable sizes with a high probability to form oil–bubble complex. Such bubbles were generated under suitable both the superficial gas

velocity and the circulating pressure. They were characterized by a high collision probability with oil droplets. Thus, the effect of separation was improved. The emulsified oil droplets were transported from the cyclone separation zone to air flotation zone by the oil–gas complex and the separation of oil from water was finished. The gas holdup plays an important role in removing oil from oily wastewater by using a cyclonic-static microbubble flotation column.

#### 4. CONCLUSIONS

- The gas holdup of flotation column increased upon increasing the circulating pressure when the air inlet valve was fully open.
- Upon increasing the circulating pressure in the flotation column, both the oil removal and the suspended solids removal efficiencies initially increased and then decreased when the circulating pressure exceeded 0.2 MPa. When the superficial gas velocity was 0.66 m/s, the gas holdup decreased gradually upon increasing the circulating pressure.
- The oil and suspended solids removal efficiencies initially increased and then decreased upon increasing the circulating pressure and superficial gas velocity. When the circulating pressure was constant with no frother addition, the holdup increased upon increasing the superficial gas velocity.
- Upon increasing the frother consumption, both the gas holdup and the oil removal efficiency increased.

#### ACKNOWLEDGEMENTS

This work was supported by the National Natural Science Foundation of China (No. 51 604 280); the Open Fund of State Key Laboratory of Mineral processing (No. BGRIMM-KJSKL-2015-03). The authors thank prof. Katarzyna Majewska-Nowak, the Editor-in-Chief of the Environment Protection Engineering, for help in the preparation of this manuscript.

#### REFERENCES

- [1] ASANO T., BURTON F.L., LEVERENZ H.L., TSUCHIHASHI R., TCHOBANOGLIOUS G., *Water Reuse Issues, Technologies and Applications*, McGraw-Hill, New York 2007, 1570.
- [2] WANG T.S., *Status and prospects for oilfield water treatment equipment*, China Petr. Machin., 1999, 27, 1.
- [3] WATCHARASING S., KONGKOWIT W., CHAVADEJ S., *Motor oil removal from water by continuous froth flotation using extended surfactant: Effects of air bubble parameters and surfactant concentration*, Sep. Purif. Technol., 2009, 70 (2), 179.
- [4] BAYATI F., SHAYEGAN J., NOORJAHAN A., *Treatment of oilfield produced water by dissolved air precipitation/solvent sublation*, J. Petr. Sci. Eng., 2011, 80 (1), 26.
- [5] LAKATOS-SZABO J., LAKATOS I., *Effect of alkaline materials on interfacial rheological properties of oil–water systems*, Colloid. Polym. Sci., 1999, 277 (1), 41.

- 
- [6] SHPINER R., LIU G., STUCKEY D.C., *Treatment of oilfield produced water by waste stabilization ponds: biodegradation of petroleum-derived materials*, *Bioresour. Technol.*, 2009, 100 (24), 6229.
- [7] LI X.B., LIU J.T., WANG Y.T., CAO Y.J., ZHOU X.H., *Separation of oil from wastewater by column flotation*, *China Univ. Min. Technol.*, 2007, 17 (4), 546.
- [8] GU X.Q., CHIANG S.H., *A novel flotation column for oily water cleanup*, *Sep. Purif. Technol.*, 1999, 16 (3), 193.
- [9] RAN J.C., LIU J.T., ZHANG C.J., WANG D.Y., LI X.B., *Experimental investigation and modeling of flotation column for treatment of oily wastewater*, *Int. J. Min. Sci. Technol.*, 2013, 23 (5), 665.
- [10] XU H.X., LIU J.T., GAO L.H., WANG Y.T., DENG X.W., LI X.B., *Study of oil removal kinetics using cyclone-static microbubble flotation column*, *Sep. Sci. Technol.*, 2014, 49 (8), 1170.
- [11] XU H.X., LIU J.T., WANG Y.T., CHENG G., DENG X.W., LI X.B., *Oil removing efficiency in oil–water separation flotation column*, *Desalin. Water Treat.*, 2015, 53 (9), 2456.
- [12] SHUKLA S.C., KUNDU G., MUKHERJEE D., *Study of gas holdup and pressure characteristics in a column flotation cell using coal*, *Miner. Eng.*, 2010, 23 (8), 636.
- [13] EUN LEE J., SIK CHOI W., KEUN LEE J., *A study of the bubble properties in the column flotation system*, *Korean J. Chem. Eng.*, 2003, 20 (5), 942.
- [14] AZGOMI F., GOMEZ C.O., FINCH J.A., *Correspondence of gas holdup and bubble size in presence of different frothers*, *Int. J. Miner. Process*, 2007, 83 (1–2), 1.
- [15] XU M., FINCH J.A., *Effect of sparger surface area on bubble diameter in flotation columns*, *Can. Metall. Quart.*, 2013, 8 (914), 1.
- [16] ZHU D., SUN S.Y., LIAO S.H., TIAN C.M., *Study on rapid determining oil in wastewater by using UV spectrum*, *J. Dail Univ.*, 2012, (12), 28.
- [17] PANG Y.H., DING Y.S., GONG W.M., *Study of measurement of oil in water using UV spectrum*, *J. Dalian Maritime Univ.*, 2002, (11), 68.